

Name \_\_\_\_\_

Reteaching

**14-6**

# Solid Figures

**1**

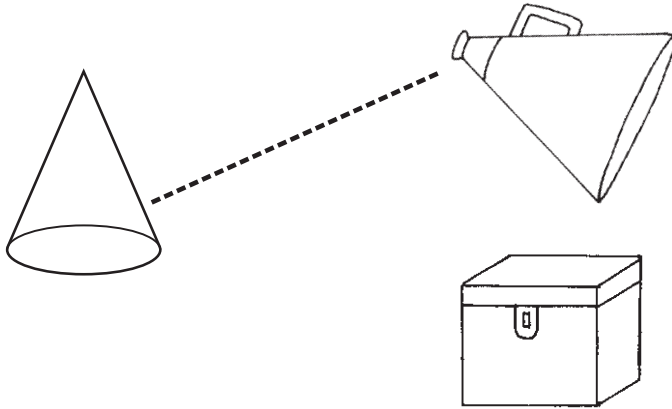

**2**

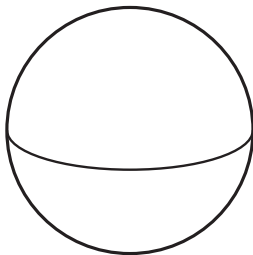
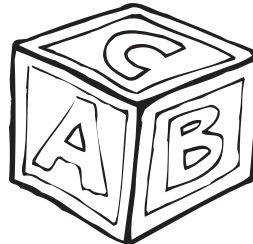
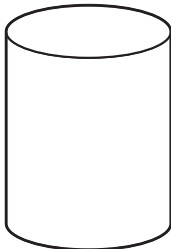
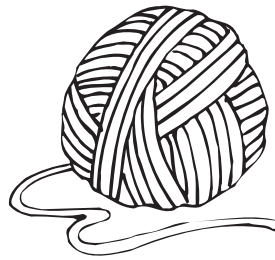
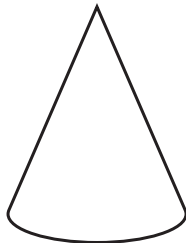
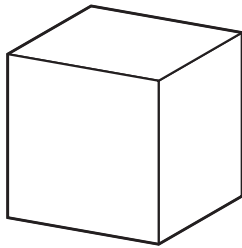

**Directions** Have children draw a line from the solid figure to the object that has the same shape.